

# LISTA DE PRECIOS

---



**ELECTRICA**

---

A-03-19

# LISTA DE PRECIOS

## INDICE

### GABINETES EQUIPO DE CONTROL

Gabinets Equipo de Control NEMA 4A FONDO 15	Pag 3
Gabinets Equipo de Control NEMA 4A FONDO 20	Pag 3
Gabinets Equipo de Control NEMA 4A FONDO 25	Pag 3
Gabinets Equipo de Control NEMA 4A FONDO 30	Pag 4
Llave Metalica para Gabinete Nema 4/IP65	Pag 4

### CONDUIT FLEXIBLE

Conduit Flexible Metalico Ultraflex - Presentacion Estandar	Pag 5
Conduit Flexible Metalico Ultraflex - Presentacion Carrete	Pag 5
Conduit Flexible Metalico Ultraflex - Presentacion 20 Metro	Pag 5
Conduit Flexible Metalico Hermetico - Recubierto PVC- Presentacion Estandar	Pag 6
Conduit Flexible Metalico Hermetico - Recubierto PVC- Presentacion Carrete	Pag 6
Conduit Flexible Metalico Hermetico - Recubierto PVC- Presentacion 20 Metros	Pag 6
Conectores Rectos para Tubo Flexible Hermetico - Metalico	Pag 7
Conectores Curvos para Tubo Flexible Hermetico - Metalico	Pag 7
Conectores Rectos para Conduit Metalico Flexible	Pag 7
Conectores Curvos para Conduit Metalico Flexible	Pag 7

### CONECTORES CONDUIT Y CABLE

Conectores Pared Delgada Zamak	Pag 8
Conectores Pared Delgada Tubular Galvanizado	Pag 8
Coples Pared Delgada Zamak	Pag 8
Coples Pared Delgada Tubular Galvanizado	Pag 8
Conectores de Compresion Pared Delgada	Pag 9
Coples de Compresion Pared Delgada	Pag 9
Monitores Metalicos para Conduit Rigido	Pag 10
Contratuercas Metalicas para Conectores y Conduit Rigido	Pag 10
Conectores tipo HUB para Conduit Rigido	Pag 10
Reducciones para Conduit Rigido - ALUMINIO	Pag 11
Reducciones para Conduit Rigido - ZAMAK	Pag 11
Conectores de Cable Uso Rudo	Pag 12
Conectores Tipo Glandula para Cable - Aluminio	Pag 12
Conectores para Cable - Plastico Gris - Contratuerca Metalic	Pag 12
Conectores para Cable - Plastico Negro - Contratuerca Metalica	Pag 12

### ABRAZADERAS LAMINA

Clipcon Universal con Tornillo	Pag 13
Mordaza CLAMP con Opresor templado	Pag 13
Mordaza CLAMP + CLIPCON Premontado (Inferior o Lateral)	Pag 13
Cinta Perforada - Rollos	Pag 13
Uña para Tubo y Conduit Rigido	Pag 14
Uña para Tubo Conduit Rigido - Economica	Pag 14
Uña para Tubo Conduit Pared Delgada	Pag 14
Uña Tubo Cobre y Tubing	Pag 14
Omega para Tubo Conduit Rigido	Pag 15
Omega para Conduit Rigido - Economica	Pag 15
Omega para Conduit Pared Delgada	Pag 15
Omegas Ligeras Grandes para Tubo PVC	Pag 15

### CONDULETS Y CAJAS

Conducones con Opresores para Conduit Pared Delgada	Pag 16
Ovalets Roscados para Conduit Rigido	Pag 16
Cajas Tipo FS de Aluminio - Pintadas	Pag 17
Tapas de Aluminio Fundidas para Cajas FS - Pintadas	Pag 17
Caja FSE NOMET para Conduit PVC	Pag 17
Tapas NOMET para Cajas FSE	Pag 17
Cajas FI de Aluminio Tipo WEATHER PROOF para Exteriores - Pintadas	Pag 18
Tapas de Aluminio Fundidas para Cajas FI - Pintadas	Pag 18
Tapon Roscado para Cajas FI	Pag 18

### OTROS PRODUCTOS ELECTRICOS

Caja Tipo Chalupa de Plastico	Pag 19
Abrazaderas NOMET para Conduit PVC	Pag 19
RACORES para Enroscar	Pag 19

### ENTRADAS ELECTRICAS

Mufas de ALUMINIO	Pag 19
Bases para Mastil de Entrada	Pag 19

### ELECTROPLASTICOS

Cinchos Negros para Interperie	Pag 20
Cinchos Transparentes para Interiores	Pag 20
Bases para Cinchos	Pag 20
Grapas Redondas con Clavo Concreto Premontad	Pag 21
Grapas Planas con Clavo Concreto Premontado	Pag 21
Empalmes para Cables	Pag 21

# LISTA DE PRECIOS



**GABINETES EQUIPO DE CONTROL**

Lista A-03-19

## GABINETES EQUIPO DE CONTROL NEMA 4A - FONDO 15

Clave Pedido	Precio	Unidad	Empaque	
			Unitario	Master
G4A 252015	\$650.00	Pieza	1	1
G4A 302515	\$895.00	Pieza	1	1
G4A 303015	\$950.00	Pieza	1	1

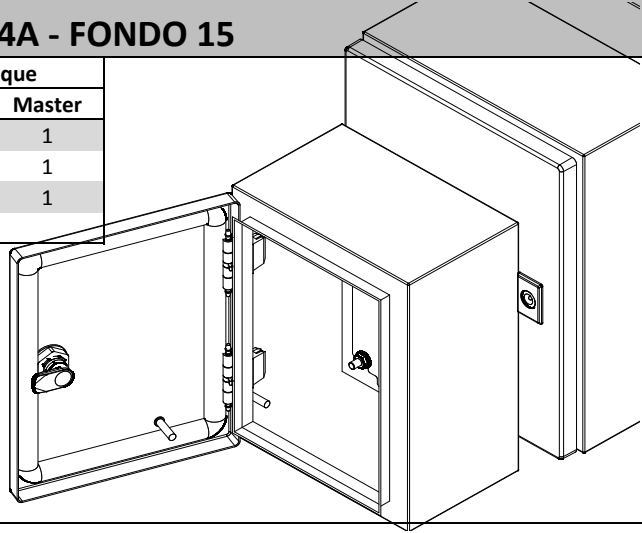

## GABINETES EQUIPO DE CONTROL NEMA 4A - FONDO 20

Clave Pedido	Precio	Unidad	Empaque	
			Unitario	Master
G4A 303020	\$1,138.00	Pieza	1	1
G4A 304020	\$1,295.00	Pieza	1	1
G4A 403020	\$1,320.00	Pieza	1	1
G4A 404020	\$1,590.00	Pieza	1	1
G4A 504020	\$1,880.00	Pieza	1	1

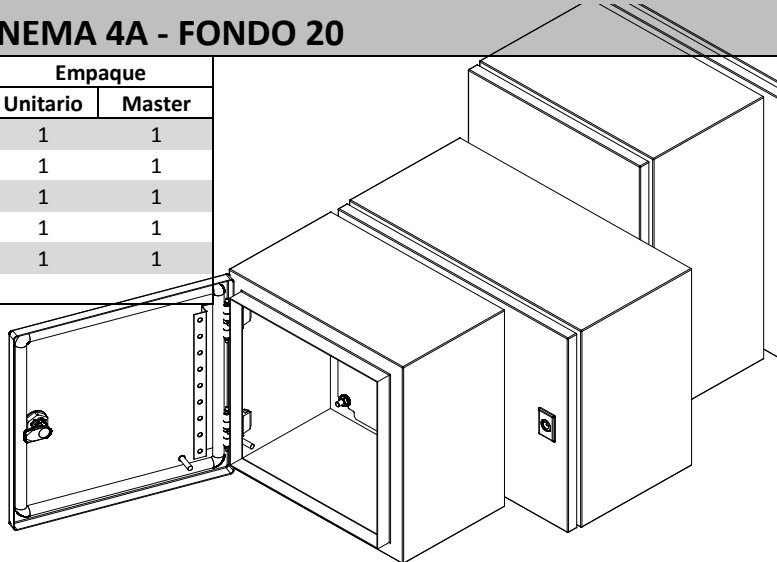

## GABINETES EQUIPO DE CONTROL NEMA 4A - FONDO 25

Clave Pedido	Precio	Unidad	Empaque	
			Unitario	Master
G4A 604025	\$2,480.00	Pieza	1	1
G4A 606025	\$3,495.00	Pieza	1	
G4A 705025	\$3,202.00	Pieza	1	

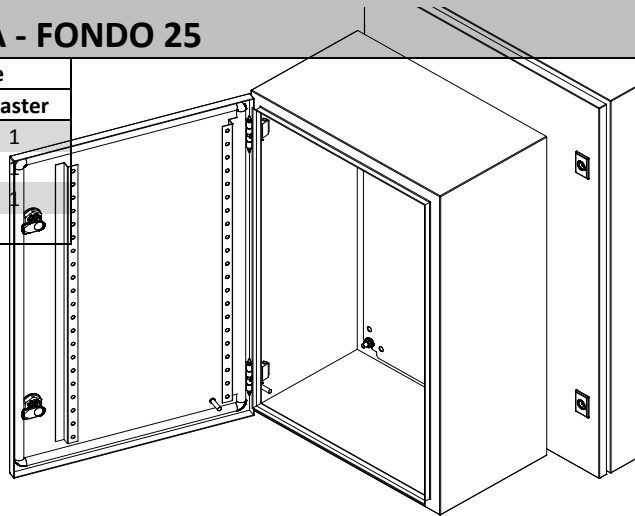

# LISTA DE PRECIOS



GABINETES EQUIPO DE CONTROL

Lista A-03-19

## GABINETES EQUIPO DE CONTROL NEMA 4A - FONDO 30

Clave Pedido	Precio	Unidad	Empaque	
			Unitario	Master
G4A 505030	\$2,685.00	Pieza	1	1
G4A 806030	\$4,873.00	Pieza	1	1
G4A 1008030	\$6,765.00	Pieza	1	1
G4A 1208030	\$7,913.00	Pieza	1	1

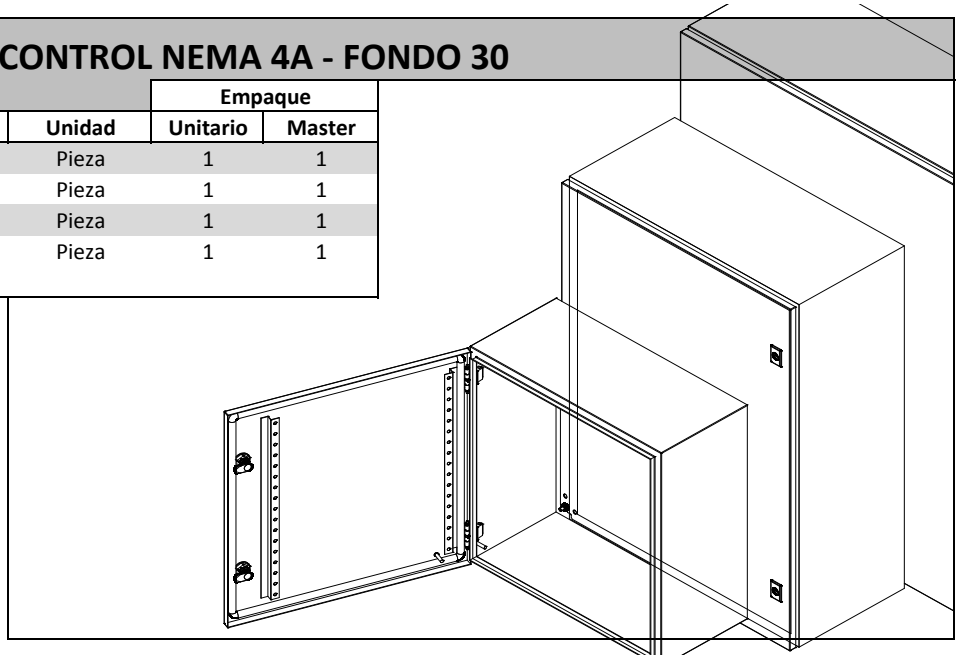

## LLAVE METALICA PARA GABINETES NEMA 4/IP65

Clave Pedido	Precio	Unidad	Empaque	
			Unitario	Master
LL-1	\$10.00	Pieza	1	1

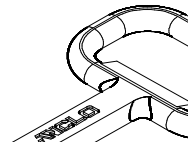

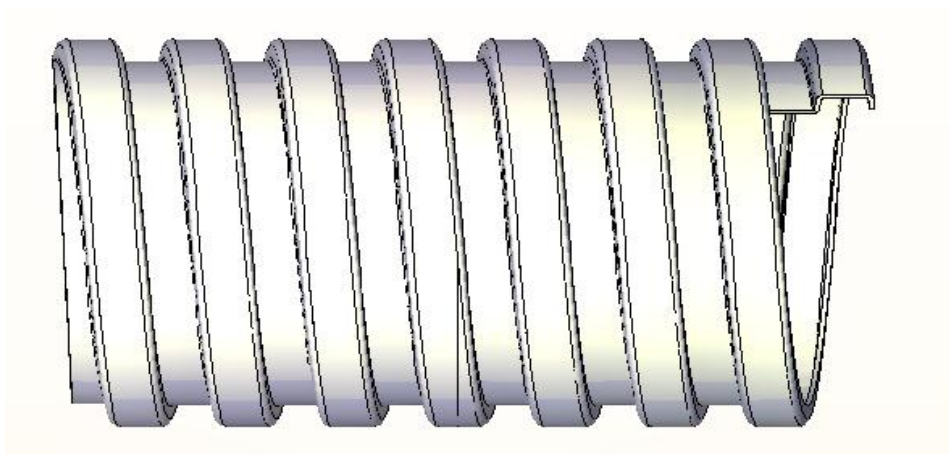

**CONDUIT FLEXIBLE METALICO ULTRAFLEX - PRESENTACION ESTANDAR**

Clave Pedido	Precio	Unidad	Empaque	
			Unitario	Master
CFX 38	\$821.00	50 mt	1	1
CFX 12	\$1,180.00	50 mt	1	1
CFX 34	\$1,650.00	50 mt	1	1
CFX 100	\$1,235.00	30 mt	1	1
CFX 114	\$1,590.00	30 mt	1	1
CFX 112	\$2,270.00	30 mt	1	1
CFX 200	\$2,690.00	30 mt	1	1
CFX 212	\$2,290.00	12 mt	1	1
CFX 300	\$2,480.00	12 mt	1	1
CFX 400	\$3,500.00	12 mt	1	1



**CONDUIT FLEXIBLE METALICO ULTRAFLEX - PRESENTACION CARRETE**

Clave Pedido	Precio	Unidad	Empaque	
			Unitario	Master
CFX 38 C	\$4,950.00	300 mt	1	1
CFX 12 C	\$5,900.00	250 mt	1	1
CFX 34 C	\$6,600.00	200 mt	1	1
CFX 100 C	\$4,930.00	120 mt	1	1



**CONDUIT FLEXIBLE METALICO ULTRAFLEX - PRESENTACION 20 METROS**

Clave Pedido	Precio	Unidad	Empaque	
			Unitario	Master
CFX 38 20	\$372.00	20 mt	1	1
CFX 12 20	\$535.00	20 mt	1	1
CFX 34 20	\$745.00	20 mt	1	1
CFX 100 20	\$930.00	20 mt	1	1



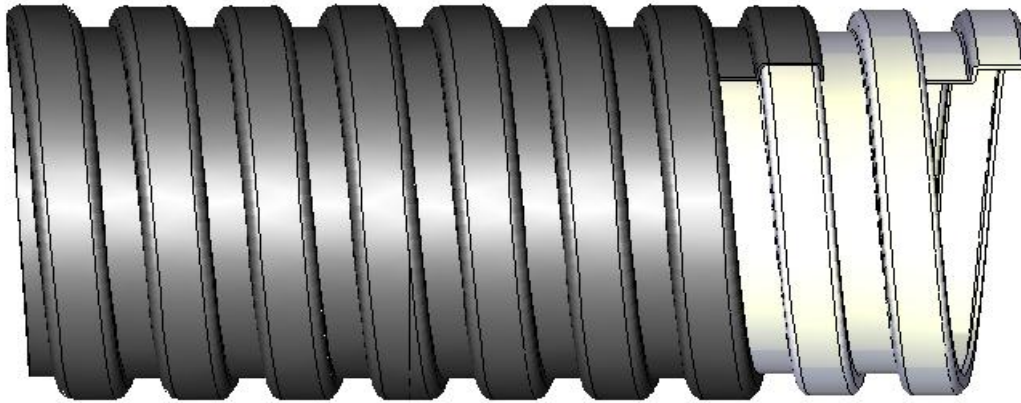

**CONDUIT FLEXIBLE METALICO HERMETICO - RECUBIERTO PVC - PRESENTACION ESTANDAR**

Clave Pedido	Precio	Unidad	Empaque	
			Unitario	Master
COT 38	\$1,530.00	50 mt	1	1
COT 12	\$1,620.00	50 mt	1	1
COT 34	\$2,160.00	50 mt	1	1
COT 100	\$1,995.00	30 mt	1	1
COT 114	\$2,350.00	30 mt	1	1
COT 112	\$3,050.00	30 mt	1	1
COT 200	\$3,830.00	30 mt	1	1
COT 212	\$2,904.00	12 mt	1	1
COT 300	\$3,960.00	12 mt	1	1
COT 400	\$5,635.00	12 mt	1	1



ORDENE CONECTORES POR SEPARADO

**CONDUIT FLEXIBLE METALICO HERMETICO - RECUBIERTO PVC - PRESENTACION CARRETE**

Clave Pedido	Precio	Unidad	Empaque	
			Unitario	Master
COT 38 C	\$9,220.00	300 mt	1	1
COT 12 C	\$8,100.00	250 mt	1	1
COT 34 C	\$8,700.00	200 mt	1	1
COT 100 C	\$8,050.00	120 mt	1	1



ORDENE CONECTORES POR SEPARADO

**CONDUIT FLEXIBLE METALICO HERMETICO - RECUBIERTO PVC - PRESENTACION 20 METROS**

Clave Pedido	Precio	Unidad	Empaque	
			Unitario	Master
COT 38 20	\$610.00	20 mt	1	1
COT 12 20	\$650.00	20 mt	1	1
COT 34 20	\$870.00	20 mt	1	1
COT 100 20	\$1,330.00	20 mt	1	1



ORDENE CONECTORES POR SEPARADO

# LISTA DE PRECIOS



CONDUIT FLEXIBLE

Lista A-03-19

## CONECTORES RECTOS PARA TUBO FLEXIBLE HERMETICO - METALICO

Clave Pedido	Precio	Unidad	Empaque	
			Unitario	Master
HLR 38	\$22.00	Pieza	100	300
HLR 12	\$22.00	Pieza	150	300
HLR 34	\$36.20	Pieza	60	180
HLR 100	\$50.30	Pieza	60	120
HLR 114	\$85.75	Pieza	35	70
HLR 112	\$105.00	Pieza	30	60
HLR 200	\$142.00	Pieza	20	40
HLR 212	\$382.00	Pieza	8	16
HLR 300	\$597.00	Pieza	4	8
HLR 400	\$812.00	Pieza	2	4

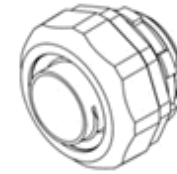

## CONECTORES CURVOS PARA TUBO FLEXIBLE HERMETICO - METALICO

Clave Pedido	Precio	Unidad	Empaque	
			Unitario	Master
HLC 38	\$31.90	Pieza	60	180
HLC 12	\$31.90	Pieza	50	150
HLC 34	\$44.40	Pieza	60	120
HLC 100	\$103.10	Pieza	30	60
HLC 114	\$156.70	Pieza	20	40
HLC 112	\$211.10	Pieza	5	20
HLC 200	\$286.00	Pieza	5	10



## CONECTORES RECTOS PARA CONDUIT METALICO FLEXIBLE

Clave Pedido	Precio	Unidad	Empaque	
			Unitario	Master
FXR 38	\$7.90	Pieza	50	400
FXR 12	\$10.00	Pieza	25	200
FXR 34	\$15.10	Pieza	20	160
FXR 100	\$23.80	Pieza	30	120
FXR 114	\$33.40	Pieza	45	90
FXR 112	\$41.20	Pieza	35	70
FXR 200	\$54.40	Pieza	15	30
FXR 212	\$169.00	Pieza	8	16
FXR 300	\$254.00	Pieza	1	15
FXR 400	\$633.00	Pieza	1	6



## CONECTORES CURVOS PARA CONDUIT METALICO FLEXIBLE

Clave Pedido	Precio	Unidad	Empaque	
			Unitario	Master
FXC 38	\$13.30	Pieza	50	200
FXC 12	\$20.00	Pieza	30	120
FXC 34	\$27.30	Pieza	25	100

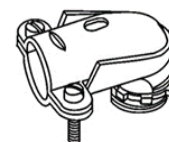

# LISTA DE PRECIOS



CONECTORES CONDUIT Y CABLE

Lista A-03-19

## CONECTORES PARED DELGADA - ZAMAK

Clave Pedido	Precio	Unidad	Empaque	
			Unitario	Master
CCL 12	\$8.25	Pieza	100	400
CCL 34	\$11.00	Pieza	60	240
CCL 100	\$16.40	Pieza	35	140
CCL 114	\$32.00	Pieza	45	90
CCL 112	\$44.50	Pieza	30	60
CCL 200	\$65.50	Pieza	15	30
CCL 212	\$159.00	Pieza	12	24
CCL 300	\$203.00	Pieza	1	16
CCL 400	\$330.00	Pieza	1	6



## CONECTORES PARED DELGADA TUBULAR - GALVANIZADO

Clave Pedido	Precio	Unidad	Empaque	
			Unitario	Master
CCA 12	\$6.00	Pieza	100	400
CCA 34	\$8.80	Pieza	65	260
CCA 100	\$10.30	Pieza	40	160

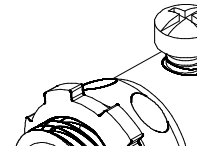

## COPLES PARED DELGADA - ZAMAK

Clave Pedido	Precio	Unidad	Empaque	
			Unitario	Master
CPD 12	\$8.25	Pieza	90	360
CPD 34	\$13.80	Pieza	45	180
CPD 100	\$21.00	Pieza	60	120
CPD 114	\$38.50	Pieza	40	80
CPD 112	\$49.00	Pieza	25	50
CPD 200	\$64.50	Pieza	18	36
CPD 212	\$165.00	Pieza	1	18
CPD 300	\$210.00	Pieza	1	12
CPD 400	\$343.00	Pieza	1	3



## COPLES PARED DELGADA TUBULAR - GALVANIZADO

Clave Pedido	Precio	Unidad	Empaque	
			Unitario	Master
CPA 12	\$6.00	Pieza	100	400
CPA 34	\$8.80	Pieza	65	260
CPA 100	\$10.30	Pieza	40	160

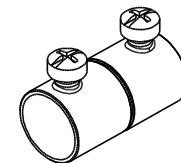



# LISTA DE PRECIOS



CONECTORES CONDUIT Y CABLE

Lista A-03-19

## CONECTORES DE COMPRESION PARED DELGADA

Clave Pedido	Precio	Unidad	Empaque	
			Unitario	Master
CNI 12	\$14.80	Pieza	50	500
CNI 34	\$23.30	Pieza	25	250
CNI 100	\$38.70	Pieza	20	200
CNI 114	\$58.80	Pieza	10	100
CNI 112	\$90.00	Pieza	1	10
CNI 200	\$129.00	Pieza	1	10



## COPLES DE COMPRESION PARED DELGADA

Clave Pedido	Precio	Unidad	Empaque	
			Unitario	Master
CPI 12	\$16.90	Pieza	50	500
CPI 34	\$29.90	Pieza	25	250
CPI 100	\$48.70	Pieza	15	100
CPI 114	\$73.30	Pieza	1	20
CPI 112	\$164.50	Pieza	1	10
CPI 200	\$171.00	Pieza	1	10

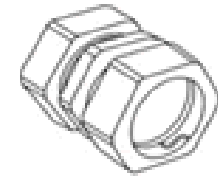

# LISTA DE PRECIOS



CONECTORES CONDUIT Y CABLE

Lista A-03-19

## MONITORES METALICOS PARA CONDUIT RIGIDO

Clave Pedido	Precio	Unidad	Empaque	
			Unitario	Master
MT 12	\$3.25	Pieza	150	1,200
MT 34	\$5.30	Pieza	150	600
MT 100	\$8.75	Pieza	120	480
MT 114	\$18.80	Pieza	120	360
MT 112	\$19.40	Pieza	150	300
MT 200	\$29.00	Pieza	70	140
MT 212	\$55.30	Pieza	40	80
MT 300	\$82.00	Pieza	25	50
MT 400	\$122.50	Pieza	15	30



## CONTRATUERCA METALICA PARA CONECTORES Y CONDUIT RIGIDO

Clave Pedido	Precio	Unidad	Empaque	
			Unitario	Master
CT 12	\$1.70	Pieza	150	2,400
CT 34	\$2.50	Pieza	120	1,920
CT 100	\$4.00	Pieza	120	960
CT 114	\$7.35	Pieza	120	480
CT 112	\$8.90	Pieza	150	450
CT 200	\$13.00	Pieza	70	280
CT 212	\$23.60	Pieza	40	160
CT 300	\$37.20	Pieza	25	75
CT 400	\$78.60	Pieza	15	45

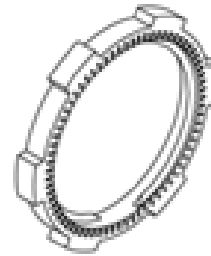

## CONECTORES TIPO HUB PARA CONDUIT RIGIDO

Clave Pedido	Precio	Unidad	Empaque	
			Unitario	Master
HUB 12	\$55.00	Pieza	25	250
HUB 34	\$69.20	Pieza	15	150
HUB 100	\$105.00	Pieza	10	100
HUB 114	\$114.00	Pieza	35	70
HUB 112	\$163.00	Pieza	1	5
HUB 200	\$224.00	Pieza	2	20

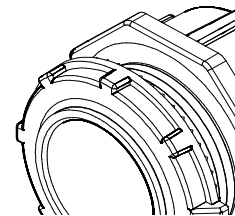

# LISTA DE PRECIOS



CONECTORES CONDUIT Y CABLE

Lista A-03-19

## REDUCCIONES PARA CONDUIT RIGIDO - ALUMINIO

Clave Pedido	Precio	Unidad	Empaque	
			Unitario	Master
REA 34 12	\$11.65	Pieza	70	560
REA 100 34	\$23.80	Pieza	40	320
REA 100 12	\$23.80	Pieza	40	320
REA 114 100	\$34.20	Pieza	25	200
REA 114 34	\$34.20	Pieza	25	200
REA 114 12	\$34.20	Pieza	25	200
REA 112 114	\$45.40	Pieza	15	120
REA 112 100	\$45.40	Pieza	15	120
REA 112 34	\$45.40	Pieza	15	120
REA 112 12	\$45.40	Pieza	20	160
REA 200 112	\$72.30	Pieza	10	80
REA 200 114	\$72.30	Pieza	10	80
REA 200 100	\$64.50	Pieza	10	80
REA 200 34	\$74.90	Pieza	10	80
REA 200 12	\$74.90	Pieza	10	80

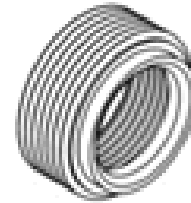

## REDUCCIONES PARA CONDUIT RIGIDO - ZAMAK

Clave Pedido	Precio	Unidad	Empaque	
			Unitario	Master
REZ 34 12	\$10.30	Pieza	100	800
REZ 100 12	\$20.70	Pieza	100	400
REZ 100 34	\$20.70	Pieza	120	480
REZ 114 100	\$28.60	Pieza	30	240
REZ 114 34	\$28.60	Pieza	30	240
REZ 114 12	\$28.60	Pieza	30	240



3/4" & 1"



1 1/4"

# LISTA DE PRECIOS



## CONECTORES CONDUIT Y CABLE

Lista A-03-19

### CONECTORES DE USO RUDO

Clave Pedido	Precio	Unidad	Empaque	
			Unitario	Master
CUR 12	\$7.00	Pieza	70	560
CUR 34	\$11.70	Pieza	80	320

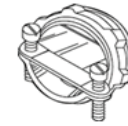

### CONECTORES TIPO GLANDULA PARA CABLE - ALUMINIO

Clave Pedido	Precio	Unidad	Empaque	
			Unitario	Master
CGB 192	\$42.00	Pieza	20	160
CGB 193	\$42.00	Pieza	20	160
CGB 194	\$42.00	Pieza	15	120
CGB 292	\$42.00	Pieza	20	160
CGB 293	\$42.00	Pieza	20	160
CGB 294	\$42.00	Pieza	20	160

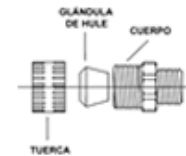

### CONECTORES PARA CABLE - PLASTICOS GRIS - CONTRATUERCA METALICA

Clave Pedido	Precio	Unidad	Empaque	
			Unitario	Master
CGP 12	\$45.40	Pieza	20	160
CGP 34	\$59.60	Pieza	20	160

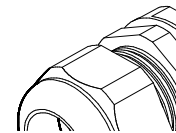

### CONECTORES PARA CABLE - PLASTICO NEGRO - CONTRATUERCA METALICA

Clave Pedido	Precio	Unidad	Empaque	
			Unitario	Master
CGN 12	\$40.00	Pieza	150	300
CGN 34	\$50.00	Pieza	80	160
CGN 100	\$104.00	Pieza	40	80
CGN 114	\$134.50	Pieza	25	50

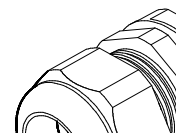

# LISTA DE PRECIOS



ABRAZADERAS LAMINA

Lista A-03-19

CLIPCON UNIVERSAL CON TORNILLO				
Clave Pedido	Precio	Unidad	Empaque	
			Unitario	Master
CLIP 12	\$6.20	Pieza	100	300
CLIP 34	\$6.60	Pieza	80	240
CLIP 100	\$8.20	Pieza	50	150
CLIP 114	\$12.60	Pieza	40	120
CLIP 112	\$13.80	Pieza	30	90
CLIP 200	\$15.60	Pieza	40	80

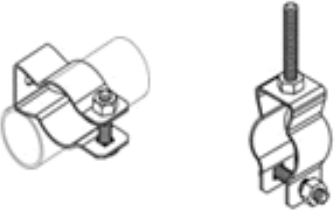

MORDAZA CLAMP CON OPRESOR TEMPLADO				
Clave Pedido	Precio	Unidad	Empaque	
			Unitario	Master
MC 3 14	\$30.15	Pieza	40	160



MORDAZA CLAMP + CLIPCON PREMONTADO (INFERIOR O LATERAL)				
Clave Pedido	Precio	Unidad	Empaque	
			Unitario	Master
MC 3 12 I			-	-
MC 3 34 I			-	-
MC 3 12 L			-	-
MC 3 34 L			-	-

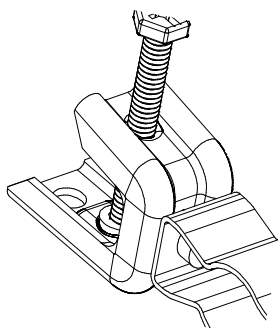

CINTA PERFORADA - ROLLOS				
Clave Pedido	Precio	Unidad	Empaque	
			Unitario	Master
CPF 3	\$42.50	Pieza	16	32
CPF 5	\$67.00	Pieza	8	16
CPF 10	\$142.00	Pieza	5	10
CPF 25	\$316.00	Pieza	4	8



UTILIZAR TORNILLOS DE 3 / 16" ó 1 / 4"

# LISTA DE PRECIOS



ABRAZADERAS LAMINA

Lista A-03-19

## UÑA PARA TUBO Y CONDUIT RIGIDO

Clave Pedido	Precio	Unidad	Empaque	
			Unitario	Master
UT 38	\$1.65	Pieza	120	960
UT 12	\$1.85	Pieza	170	680
UT 34	\$3.40	Pieza	100	400
UT 100	\$4.25	Pieza	90	360
UT 114	\$7.25	Pieza	60	180
UT 112	\$8.50	Pieza	40	120
UT 200	\$16.50	Pieza	25	75
UT 212	\$32.50	Pieza	20	60
UT 300	\$47.80	Pieza	35	70
UT 400	\$59.50	Pieza	25	50



## UÑA PARA TUBO CONDUIT RIGIDO - ECONOMICA

Clave Pedido	Precio	Unidad	Empaque	
			Unitario	Master
UE 12	\$1.35	Pieza	200	800
UE 34	\$1.85	Pieza	130	520
UE 100	\$3.00	Pieza	100	400
UE 114	\$5.55	Pieza	70	210
UE 112	\$6.45	Pieza	40	120
UE 200	\$7.90	Pieza	30	90



## UÑA PARA TUBO CONDUIT PARED DELGADA

Clave Pedido	Precio	Unidad	Empaque	
			Unitario	Master
UC 12	\$1.35	Pieza	250	1,000
UC 34	\$1.85	Pieza	150	600
UC 100	\$3.00	Pieza	120	480
UC 114	\$5.55	Pieza	70	210
UC 112	\$6.45	Pieza	50	150
UC 200	\$7.90	Pieza	45	135



## UÑA TUBO COBRE Y TUBING

Clave Pedido	Precio	Unidad	Empaque	
			Unitario	Master
UCR 14	\$1.10	Pieza	200	1,600
UCR 38	\$1.35	Pieza	150	1,200
UCR 12	\$1.95	Pieza	120	960
UCR 34	\$2.70	Pieza	100	800



# LISTA DE PRECIOS



ABRAZADERAS LAMINA

Lista A-03-19

## OMEGA PARA TUBO CONDUIT RIGIDO

Clave Pedido	Precio	Unidad	Empaque	
			Unitario	Master
OT 12	\$3.50	Pieza	120	480
OT 34	\$4.25	Pieza	80	320
OT 100	\$4.90	Pieza	60	240
OT 114	\$9.40	Pieza	40	120
OT 112	\$10.70	Pieza	30	90
OT 200	\$15.60	Pieza	25	75
OT 212	\$26.20	Pieza	30	60
OT 300	\$33.40	Pieza	25	50
OT 400	\$49.70	Pieza	1	50



## OMEGA PARA CONDUIT RIGIDO - ECONOMICA

Clave Pedido	Precio	Unidad	Empaque	
			Unitario	Master
OE 12	\$1.75	Pieza	150	600
OE 34	\$2.65	Pieza	80	320
OE 100	\$3.40	Pieza	60	240
OE 114	\$6.60	Pieza	40	120
OE 112	\$8.90	Pieza	30	90
OE 200	\$12.00	Pieza	20	60



## OMEGA PARA CONDUIT PARED DELGADA

Clave Pedido	Precio	Unidad	Empaque	
			Unitario	Master
OC 12	\$1.75	Pieza	200	800
OC 34	\$2.65	Pieza	150	600
OC 100	\$3.40	Pieza	100	400
OC 114	\$6.60	Pieza	60	180
OC 112	\$8.90	Pieza	50	150
OC 200	\$12.00	Pieza	40	120

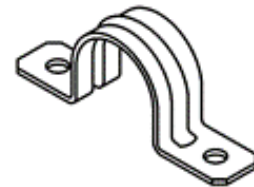

## OMEGAS LIGERAS GRANDES PARA TUBO PVC

Clave Pedido	Precio	Unidad	Empaque	
			Unitario	Master
OD 600	\$91.00	Pieza	1	20
OD 800	\$115.00	Pieza	1	5
OD 1000	\$118.00	Pieza	1	5
OD 1200	\$130.00	Pieza	1	5



**CONDUCONES CON OPRESORES PARA CONDUIT PARED DELGADA**

Clave Pedido	Precio	Unidad	Empaque	
			Unitario	Master
CLB 12	\$46.40	Pieza	5	65
CLB 34	\$58.70	Pieza	5	50
CCC 12	\$50.20	Pieza	5	50
CCC 34	\$63.30	Pieza	5	50
CCT 12	\$52.40	Pieza	5	50
CCT 34	\$69.90	Pieza	4	36
CLL 12	\$50.20	Pieza	5	75
CLL 34	\$63.30	Pieza	4	48
CLR 12	\$50.20	Pieza	5	75
CLR 34	\$63.30	Pieza	4	48

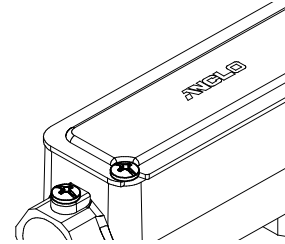

**OVALETS ROSCADOS PARA CONDUIT RIGIDO**

Clave Pedido	Precio	Unidad	Empaque	
			Unitario	Master
OLB 12	\$46.40	Pieza	1	70
OLB 34	\$58.70	Pieza	1	50
OLB 100	\$86.90	Pieza	1	32
OLB 114	\$198.00	Pieza	1	12
OLB 112	\$203.00	Pieza	1	12
OLB 200	\$379.00	Pieza	1	6
OCE 12	\$50.20	Pieza	1	85
OCE 34	\$63.30	Pieza	1	50
OCE 100	\$85.40	Pieza	1	37
OCE 114	\$197.00	Pieza	1	15
OCE 112	\$200.00	Pieza	1	15
OCE 200	\$392.00	Pieza	1	10
OTE 12	\$52.40	Pieza	1	60
OTE 34	\$69.90	Pieza	1	36
OTE 100	\$92.00	Pieza	1	26
OTE 114	\$202.50	Pieza	1	10
OTE 112	\$207.00	Pieza	1	10
OTE 200	\$415.00	Pieza	1	6
OLR 12	\$50.20	Pieza	1	70
OLR 34	\$63.30	Pieza	1	48
OLR 100	\$85.40	Pieza	1	32
OLR 114	\$197.00	Pieza	1	10
OLR 112	\$209.00	Pieza	1	10
OLR 200	\$429.00	Pieza	1	6
OLR 212	\$1,098.00	Pieza	1	4
OLL 12	\$50.20	Pieza	1	70
OLL 34	\$63.30	Pieza	1	48
OLL 100	\$85.40	Pieza	1	32
OLL 114	\$197.00	Pieza	1	10
OLL 112	\$209.00	Pieza	1	10
OLL 200	\$428.00	Pieza	1	6



OLB



OCE



OTE

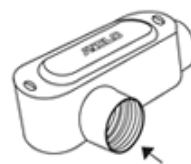

OLR



OLL



# LISTA DE PRECIOS



CONDULETS Y CAJAS

Lista A-03-19

## CAJAS TIPO FS DE ALUMINIO - PINTADAS

Clave Pedido	Precio	Unidad	Empaque	
			Unitario	Master
FS 12	\$85.60	Pieza	3	30
FS 34	\$87.20	Pieza	3	30
FSC 12	\$90.80	Pieza	3	27
FSC 34	\$94.00	Pieza	3	27
FSS 12	\$98.20	Pieza	3	30
FSS 34	\$101.50	Pieza	3	30
FST 12	\$102.60	Pieza	4	20
FST 34	\$103.50	Pieza	4	20
FSR 12	\$102.50	Pieza	4	24
FSR 34	\$103.50	Pieza	4	24
FSL 12	\$92.50	Pieza	4	24
FSL 34	\$103.50	Pieza	4	24
FS 100	\$100.00	Pieza	3	30
FSC 100	\$115.00	Pieza	3	27
FST 100	\$121.00	Pieza	4	20

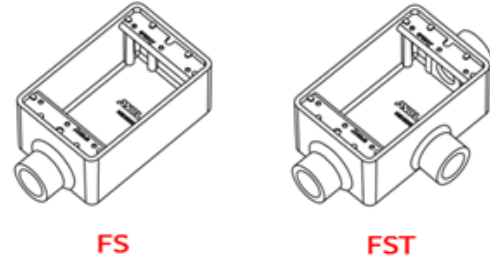

FS

FST

## TAPAS DE ALUMINIO FUNDIDAS PARA CAJAS FS - PINTADAS

Clave Pedido	Precio	Unidad	Empaque	
			Unitario	Master
DS 10	\$21.00	Pieza	1	180
DS 10E	\$23.70	Pieza	1	180
DS 21	\$21.00	Pieza	1	180
DS 22	\$21.00	Pieza	1	180
DS 23	\$21.00	Pieza	1	180
DS 32	\$21.00	Pieza	1	180
DS 33	\$21.00	Pieza	1	180

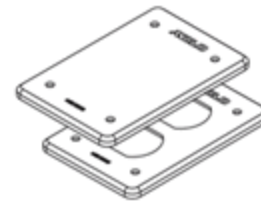

Aluminio



## CAJA FSE NOMET PARA CONDUIT PVC

Clave Pedido	Precio	Unidad	Empaque	
			Unitario	Master
FE 12 34	\$25.50	Pieza	1	50
FEC 12 34	\$28.00	Pieza	1	50
FET 12 34	\$32.00	Pieza	1	50

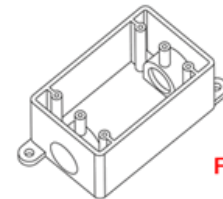

FE

\* Se incluyen reducciones a 1/2 en todos los modelos

## TAPAS NOMET PARA CAJAS FSE

Clave Pedido	Precio	Unidad	Empaque	
			Unitario	Master
DE 10	\$12.00	Pieza	100	200
DE 23	\$12.00	Pieza	100	200



DE

# LISTA DE PRECIOS



CONDULETS Y CAJAS

Lista A-03-19

## CAJAS FI DE ALUMINIO TIPO WEATHER PROOF PARA EXTERIORES - PINTADAS

Clave Pedido	Precio	Unidad	Empaque	
			Unitario	Master
FI 12	\$73.70	Pieza	3	30
FI 34	\$76.00	Pieza	3	30
FIC 12	\$78.40	Pieza	4	32
FIC 34	\$80.00	Pieza	4	32
FIT 12	\$92.50	Pieza	3	24
FIT 34	\$93.00	Pieza	3	24
FIX 12	\$83.70	Pieza	3	27
FIX 34	\$90.50	Pieza	3	27
FIA 12	\$93.50	Pieza	1	30
FIA 34	\$95.80	Pieza	1	30

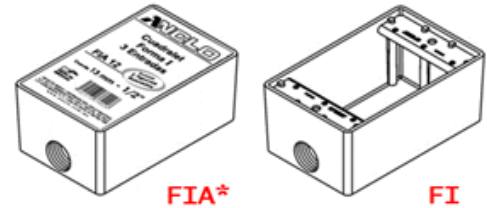

## TAPAS DE ALUMINIO FUNDIDAS PARA CAJAS FI - PINTADAS

Clave Pedido	Precio	Unidad	Empaque	
			Unitario	Master
DI 10	\$25.40	Pieza	1	144
DI 23	\$23.40	Pieza	1	144
DI 21	\$29.00	Pieza	1	144
DI 22	\$27.80	Pieza	1	144
DI 10E	\$26.40	Pieza	1	144
DI 32	\$29.00	Pieza	1	144
DI 33	\$28.20	Pieza	1	144
DI 34	\$29.40	Pieza	1	144
DI 35	\$28.20	Pieza	1	144
DI 36	\$27.60	Pieza	1	144

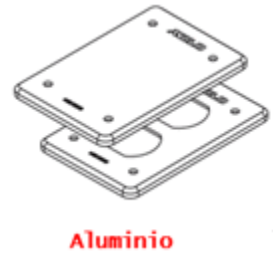

## TAPON ROSCADO PARA CAJAS FI

Clave Pedido	Precio	Unidad	Empaque	
			Unitario	Master
TRZ 12	\$8.25	Pieza	100	1,000
TRZ 34	\$14.20	Pieza	50	800



# LISTA DE PRECIOS



## OTROS PRODUCTOS ELECTRICOS

Lista A-03-19

### CAJA TIPO CHALUPA DE PLASTICO

Clave Pedido	Precio	Unidad	Empaque	
			Unitario	Master
FD 1	\$8.00	Pieza	1	120

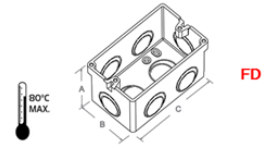

### ABRAZADERAS NOMET PARA CONDUIT PVC

Clave Pedido	Precio	Unidad	Empaque	
			Unitario	Master
ON 12	\$1.10	Pieza	150	300
ON 34	\$1.45	Pieza	150	300

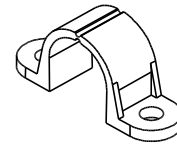

### RACORES PARA ENROSCAR

Clave Pedido	Precio	Unidad	Empaque	
			Unitario	Master
FXE 38	\$6.00	Pieza	250	750
FXE 12	\$7.60	Pieza	180	540
FXE 34	\$10.80	Pieza	180	360



## ENTRADAS ELECTRICAS

Lista A-03-19

### MUFAS DE ALUMINIO

Clave Pedido	Precio	Unidad	Empaque	
			Unitario	Master
MUF 34	-	Pieza	-	-
MUF 114	\$35.50	Pieza	1	45



### BASES PARA MASTIL DE ENTRADA

Clave Pedido	Precio	Unidad	Empaque	
			Unitario	Master
BSD 34	\$31.50	Pieza	4	80
BSD 100	\$32.50	Pieza	4	80
BSD 114	\$34.20	Pieza	4	64
BSD 112	\$35.50	Pieza	4	64
BSD 200	\$36.10	Pieza	4	64

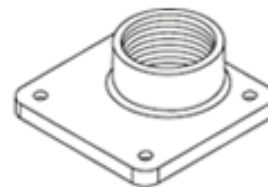

# LISTA DE PRECIOS



ELECTROPLASTICOS

Lista A-03-19

## CINCHOS NEGROS PARA INTERPERIE

Clave Pedido	Precio	Unidad	Empaque	
			Unitario	Master
ACN 100-2	\$18.80	Cientos	1	600
ACN 140-2	\$30.90	Cientos	1	350
ACN 200-2	\$41.20	Cientos	1	280
ACN 140-3	\$48.20	Cientos	1	250
ACN 180-3	\$61.80	Cientos	1	170
ACN 300-3	\$103.70	Cientos	1	150
ACN 370-3	\$143.20	Cientos	1	120
ACN 190-4	\$81.50	Cientos	1	100
ACN 300-4	\$138.80	Cientos	1	100
ACN 370-4	\$200.00	Cientos	1	90

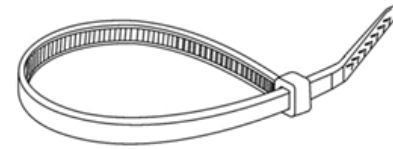

ACT / ACN

## CINCHOS TRASPARENTES PARA INTERIORES

Clave Pedido	Precio	Unidad	Empaque	
			Unitario	Master
ACT 100-2	\$18.80	Cientos	1	600
ACT 140-2	\$30.90	Cientos	1	350
ACT 200-2	\$41.20	Cientos	1	280
ACT 140-3	\$48.20	Cientos	1	250
ACT 180-3	\$61.80	Cientos	1	170
ACT 300-3	\$103.70	Cientos	1	150
ACT 370-3	\$143.20	Cientos	1	120
ACT 190-4	\$81.50	Cientos	1	130
ACT 300-4	\$138.80	Cientos	1	100
ACT 370-4	\$200.00	Cientos	1	90

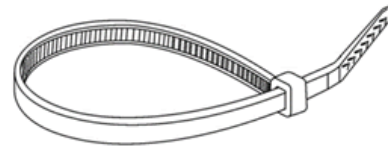

ACT / ACN

## BASES PARA CINCHOS

Clave Pedido	Precio	Unidad	Empaque	
			Unitario	Master
BAC 34	\$200.00	Cientos	1	220
BAC 114	\$340.00	Cientos	1	100

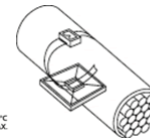

No usar en exteriores o en lugares



BAC

# LISTA DE PRECIOS



ELECTROPLASTICOS

Lista A-03-19

## GRAPAS REDONDAS CON CLAVO CONCRETO PREMONTADO

Clave Pedido	Precio	Unidad	Empaque	
			Unitario	Master
GR 5	\$35.00	Cientos	1	350
GR 6	\$37.00	Cientos	1	250
GR 8	\$48.00	Cientos	1	200
GR 10	\$62.00	Cientos	1	150
GR 12	\$80.00	Cientos	1	150
GR 14	\$113.00	Cientos	1	150
GR 16	\$145.00	Cientos	1	70
GR 22	\$210.00	Cientos	1	52
GR 26	\$230.00	Cientos	1	30



## GRAPAS PLANAS CON CLAVO CONCRETO PREMONTADO

Clave Pedido	Precio	Unidad	Empaque	
			Unitario	Master
GP 5	\$37.00	Cientos	1	450
GP 8	\$39.00	Cientos	1	200
GP 9	\$42.50	Cientos	1	175
GP 10	\$50.00	Cientos	1	150



## EMPALMES PARA CABLES

Clave Pedido	Precio	Unidad	Empaque	
			Unitario	Master
E-1	\$83.50	Cientos	1	500
E-2	\$96.20	Cientos	1	350
E-3	\$133.70	Cientos	1	180
E-4	\$169.30	Cientos	1	120
E-5	\$282.00	Cientos	1	90

